



CS100 User Guide



Multitone Electronics plc

Head Office
Multitone House
Shortwood Copse Lane
Kempshott
Basingstoke
Hampshire
RG23 7NL
Tel: +44 (0) 1256 320292
Fax: +44 (0) 1256 462643
E-Mail: Info@multitone.com
www.multitone.com

UK Sales & Service Office and Customer Helpdesk

Unit 33, Geddes House
Kirkton North
Livingston
West Lothian
EH54 6GU
Tel: 01506 418198
Fax: 01506 411711

Multiton Elektronik GmbH

Rossstrasse 11
40476 Dusseldorf
GERMANY
PO Box 320760
vertrieb@www.multiton.de

Multiton Comm.Syst. Pty Ltd

Level 5
43-51 Queen Street
Melbourne
Victoria 3000
AUSTRALIA

CS100 System User Guide

Contents

| | Page |
|--|-----------|
| 1. CS100 System Overview Section | 4 |
| 1.0 CS100 System Overview | 6 |
| 1.1 CS100 System Specifications | 7 |
| 1.2 Handset Options | 8 |
| 1.3 Repeaters / Extended Range | 9 |
| 2. Equipment Setup and Configuration Section | 10 |
| 2.1 System Components | 12 |
| 2.2 Guidelines for Installation of the CS100 Base Station | 13 |
| 2.3 Preparation for Installation | 14 |
| 2.4 Wiring up the CS100 Master Base Station | 17 |
| 3. Master Handset Configuration Section | 21 |
| 3.1 Master Handset Configuration | 22 |
| 3.2 Registering the Master Handset | 23 |
| 3.3 Allocating the Master Handset Extension Number | 24 |
| 3.4 Registering Additional Handsets via the Master Handset | 25 |
| 3.5 Deleting Previously Registered Handsets | 26 |
| 4. PC Software Configuration Section | 27 |
| 4.1 Installing the CCFP Administration Software | 28 |
| 4.2 Configuring the CCFP Software for the first time | 30 |
| ⊙ Phone Book | 31 |
| ⊙ Editing Phone Book | 32 |
| ⊙ MSF (Message Service Function) | 33 |
| ⊙ MSF Status | 34 |
| ⊙ Registration Screen | 35 |
| ⊙ Handset registration | 36 |
| ⊙ CCFP Setup | 37 |
| ⊙ Status Message Level | 38 |
| ⊙ File Menu | 39 |
| ⊙ Options Menu | 39 |
| ⊙ Technical Appendix Debug | 40 |
| ⊙ Impedance Setup | 41 |

Contents (continued)

| | Page |
|---|-----------|
| 5. Repeater and Handset Programming | 42 |
| 5.1 Start up text | 42 |
| 5.2 Instructions for Installation and Configuration | 43 |
| Ⓞ Determining location of repeaters | 44 |
| 5.3 Setting up Repeaters | 45 |
| 5.4 Powering up and Testing | 46 |
| 5.5 Kirktool Software Installation | 47 |
| Ⓞ Communicating with the Kirktool Software | 48 |
| 5.6 Registering a Repeater | 50 |
| 5.7 Establishing Repeater Jumps | 52 |
| 6. Frequently asked Questions | 53 |
| 7. CS100 Messaging | 55 |
| 8. Technical Specifications Section | 57 |
| 8.1 CS100 System features for all 8 DECT lines | 57 |
| 8.2 IWU Setup for CCFP Administration Program | 58 |

CS100 System Overview

1. **CS100 System Overview**
 - 1.1 CS100 System Specifications
 - 1.2 Handset Options
 - 1.3 Repeaters / Extended Range

System Overview

This page has intentionally been left blank.

1. CS100 System Overview



- ⊙ A cordless telephone system with excellent range allows you to make or receive calls even when you are away from your desk
- ⊙ The system is based on the open European DECT/GAP standard and is easily tailored to suit different requirements
- ⊙ Coverage can be extended at any time by simply installing a Repeater
- ⊙ Up to 6 people can make or receive calls at the same time
- ⊙ The CS100 System is simple to install and configure

The CS100 System is a small business mobile communications solution. It connects up to 8 wireless handsets direct to your existing Telephone System, providing your workforce with the ability to communicate from anywhere within CS100 system Master or repeater radio coverage.

By adding Repeaters at strategic locations, coverage can easily be extended to suit your needs.

A repeater allows the user to roam over larger areas without losing the call.

This feature rich mobile solution means that your staff are no longer tied to their desks, and can talk to your customers whilst on the move. This will improve productivity, morale, and customer satisfaction.

The CS100 is an OEM branded product that can be used with Multitone CH70 DECT Handsets. It can also be used with Multitone's messaging products P318 & access integrator. The messaging products are designed for connection to moving contact alarms which can be used to trigger security alerts, alarms or similar messaging alerts to CH70 handsets. Access integrator connects to a LAN, and may be used to message single DECT users or teams of users. In addition both products have serial ports that can be connected to fire alarms, or other data inputs (Manufacturing/processing)

Contact sales support or www.multitone.com for more details.

1.1 CS100 System Specifications



- ⊙ Range – up to 300m
- ⊙ Handsets can be registered via a Master handset – or using a PC
- ⊙ Supports up to 8 handsets
- ⊙ 6 handsets can make or receive calls simultaneously
- ⊙ Measurements – 150 x 150mm
- ⊙ Connects to the Host PABX by a twisted pair standard telephone cable
- ⊙ Base unit can be placed up to 7000 metres from the switchboard depending on PABX limits
- ⊙ LED lights to indicate operations status

The CS100 is a single cell DECT System that allows up to 8 wireless handsets to be connected, covering an area of up to 300 metres from where it is placed. It is an adjunct to a PABX for 8 A/B connections and a RS232 computer programming interface.

Up to 6 repeaters can be used with a maximum of 3 of the repeaters 'daisy chained' to extend the coverage area. As you move outside the range of the base unit, coverage will be handed over to the repeater so that the call doesn't get dropped.

A computer is NOT required to run the CS100 system, although system administration software is supplied and recommended. Handsets can be logged in to the system using the 'Master' handset, which is configured during installation.

Analogue A/B Line Features

The inter working unit creates the interface between 8 analogue lines and the digital lines in the DECT system. The A/B lines are all galvanically isolated from the rest of the CS100 DECT System and from each other.

Features for all 8 lines:

- ⊙ DTMF transmit and Single tone receive
- ⊙ DTMF receive and Single tone transmit (Option)
- ⊙ Echo cancelling
- ⊙ Echo suppression
- ⊙ Pulse generating
- ⊙ Ringing detection
- ⊙ Loop break
- ⊙ Galvanic isolation

1.2 Handset options

Note: the handset used in this example is the Multitone CH70. Other DECT handsets are compatible with the CS100 System, although operating instructions may vary. Multitone cannot give support for 3rd party handsets - for more information see chapter 6.



Key features:

- ⊙ DECT technology
- ⊙ 121 grams
- ⊙ 145 x 50 x 23 (mm)
- ⊙ 10 hours active talk-time
- ⊙ 90 hours standby
- ⊙ 65 number telephone memory
- ⊙ Silent vibrate alert option
- ⊙ Automatic call answering
- ⊙ Large LCD for text messaging with backlit display
- ⊙ Caller ID - between DECT handsets
- ⊙ Headset jack for 'Hands-free' option
- ⊙ GAP/CAP compliant

The CH70 cordless handset is compact, robust and simple to use. Its lightweight and slim design makes this the perfect pocket phone, without compromising on performance or features.

The CH70 can be used independently, or together with a standard desk phone. Sharing the same telephone number means that there are no new extension numbers to remember, so people will always be able to contact you at the one number. You can set either phone to ring (or both!) and transferring a conversation from one phone to another is effortless.

This phone is purpose built for use in many working situations. For example, someone working in a noisy environment may use the vibrate module to ensure they know when a call is incoming; a machine operator may use the hands-free option with auto-answer capabilities. An ear defender headset can also be used.

A range of accessories is available to support this phone, and increase functionality. These include:

- ⊙ Headset
- ⊙ Ear defenders
- ⊙ Belt clip
- ⊙ Holster
- ⊙ Hands free docking station



1.3 Repeaters / Extended Range



Key Features:

- ⊙ Extend area of Radio coverage easily and within minutes
- ⊙ Eliminate areas of poor coverage
- ⊙ Range of up to 300 metres
- ⊙ Provide external coverage - useful for car parks or other outdoor areas
- ⊙ 'Daisy Chain' up to 3 Repeaters to cover larger areas, such as a warehouse or extended office area

The CS100 system base unit has a coverage range of up to 300 metres. However, this can be easily extended to suit your needs by adding 'Repeaters'. The range of the base Station and repeater depends upon the working environment.

Repeaters are used to increase the range of coverage over a larger area. If you find the CS100 system base unit coverage does not reach a certain part of your building, you can simply add a repeater near the outside range of the base unit, thus eradicating signal drops and weak areas (Figure 1).

The CS100 system can support up to 6 Repeaters, up to 3 of which can be 'daisy chained' to form a long coverage area – ideal for large warehouses (Figure 2).

Each repeater or repeater chain has a maximum of 2 speech channels.

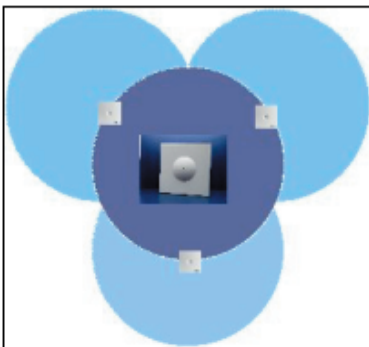

Figure 1: 3 repeaters are used to extend coverage over a much larger area

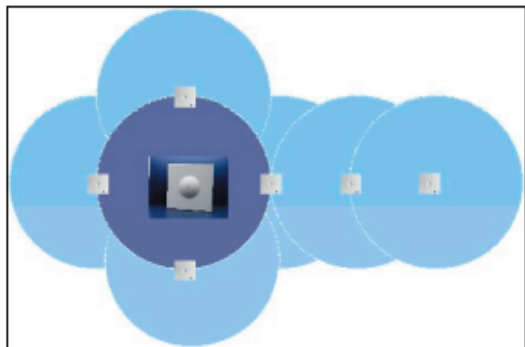

Figure 2: 3 repeaters have been chained to extend coverage over a long area, such as an open plan office or warehouse.

Equipment Installation

- 2. Equipment Setup and Configuration**
 - 2.1 System Components
 - 2.2 Guidelines for Installation
 - 2.3 Preparation & Installation of the CS100 Base Station
 - 2.4 Wiring up the CS100 Master Base Station
 - 2.5 Powering up and Testing

Equipment Installation

This page has intentionally been left blank.

2. Equipment Setup and Configuration

2.1 System Components

The following components are supplied with the CS100 Base Station system:

- 1 x CS100 Base Station unit
- 1 x PSU - 3 metre cable
- 1 x Technical user guide (this guide)
- 2 x screws and rawl plugs

The PC Programming cables for the CS100 Base Station and Repeaters are sold separately.

A choice of 2 programming cables are available

0361-6928 9 way D - RJ45

0361-6929 25 way D - RJ45

Programming software can be down loaded from www.multitone.com

You will require the following tools to complete the installation:

- ⦿ Wire cutters
- ⦿ Small Philips screwdriver
- ⦿ Drill & suitable bits

2.2 Guidelines for Installation of the CS100 Base Station

When deciding the location of the CS100 Base Station, consider what area of your office or work place you need the most coverage. This should also take into account the number of people who will be using a handset within a given area. Try to place the Base Station as centrally as possible to ensure maximum efficiency, unless external coverage is required.

A 240-volt mains power socket must be available within 3 metres of the fixing point of the CS100 Base Station.

Keep the Base Station 1.5 meters clear from any electrical equipment such as computers and fax machines. These devices can cause Electro-Magnetic Interference (EMI), weakening the radio signal.

The Base Station must be kept in an area where the temperature is maintained within the limits of 0 - 50°C. The air must not be damp or humid, and must be free from water spray or a conductive/corrosive atmosphere and out of direct sunlight.

In order to get the best signal coverage, place the Base Station as high as possible, but at least 4" (10 cm) from the ceiling or any metallic surfaces. Also, foil insulated plasterboard or any other similar foil insulation may affect performance.

For information on testing the coverage and signal strength, see section 5.4 – 'Powering up and Testing'.

2.3 Preparing for Installation

Before you begin to install and configure your new CS100 system it is recommended that you take note of the following points to ensure a smooth installation.

About DECT

DECT is a low power radio standard for telecommunications. Transmission from the base unit can achieve a coverage radius of 300m in clear space. However the distance that will be achieved in your installation depends very much on the location you choose for the Base unit and any repeaters you install. Coverage from a base unit in the wrong location could be less than 10m. Thick walls, dense concrete, tinted glass with a high metal content and metal clad buildings, all may attenuate the signal.

If you are concerned that you may have a coverage problem then a coverage survey should be carried out prior to installation. A survey kit can be rented/purchased from your system supplier or carried out using the CS100 and the master handset.

Choosing a location for the CS-100 base unit

- ⊙ The CS100 can be placed up to 7.5km (subject to Host PABX) from the PBX. Mains power should be within 3 metres. The Unit should be Placed in the geographic centre of the area to be covered unless:
 - (a) The majority of users would be located out of range of the CS100 base unit.†
 - (b) The location is External.
 - (c) The unit would be located in a hostile environment (such as refrigerated room).

The Unit should be Located at Least 10cm away from any metal surface and the same distance from the ceiling or corners of the room. The more free space around the unit the better.

Choose a location that is free of any obstructions (such as racking or filing cabinets).

Avoid locating CS100 in the void area of suspended ceilings.

Although a high location is good it may be necessary in the future to connect a PC to the CS100 for administration or maintenance. In this case locate within 3 metres of the PC or Laptop position.

If an External location is chosen for siting the unit please call your supplier for further advice before proceeding with the installation.

† See Section 2.2

Choosing a location for a repeater.

It is important that a repeater is located within the good coverage area of the base unit. Failure to do so will result in apparent poor reception for any handset connecting to the repeater.

The Unit should be Located at Least 10cm away from any metal and the same distance from the ceiling or corners of the room. The more free space around the unit the better. Choose a location that is free of any obstructions (such as racking or filing cabinets). Although a high location is good it may be necessary in the future to connect a PC to the CS100 for administration or maintenance.

Avoid locating Repeater in the void area of suspended ceilings.

If an External location is chosen for siting the unit please call your supplier for further advice before proceeding with the installation.

Unpacking your CS100 System

- ⊙ Check all equipment for damage, and correct delivery
- ⊙ Assemble all handsets and chargers ready for battery charging

Installation and Configuration

- ⊙ Charge all handset batteries
- ⊙ Determine the location for the CS100 Base Station
- ⊙ Register the Master handset and all other user handsets
- ⊙ Test CS100 Base Station coverage
- ⊙ Assuming coverage is OK install the CS100 Base Station
- ⊙ Determine the location for any Repeaters
- ⊙ Register and configure Repeaters
- ⊙ Test coverage handled by Repeaters
- ⊙ Assuming coverage is OK install any Repeaters
- ⊙ Verify system operation and installation successful

* Charging your handset battery packs

When supplied, your DECT handset battery pack will contain only a low residual charge. To ensure reliable operation, ensure you fully charge the battery packs. For the initial charge, allow up to 14 hours to ensure the battery is fully charged. This process will take approximately 3fi hours (from fully discharged to fully charged) during normal operation.

For instructions on charging batteries, consult the user guide supplied with your DECT handset

2.4 Wiring up the CS100 Base Station

To wire up the CS100 Base Station, remove the front facia by gently releasing the 4 clips on the rear of the unit. At the top of the circuit board, there is a screw keeping the board in place – remove this screw to release the board from the case. Follow anti-static precautions while handling the PCB. Now follow these steps:

1. Carefully remove the circuit board from the housing
2. Cable can be inserted through any of the 4 passages in the base of the housing. Remove the 'Break out' tab from the cable passage convenient to your installation
3. Insert the cabling through the hole
4. Secure the cable using the bracket and screws provided
5. Connect the wires into the connector at the bottom of the circuit board

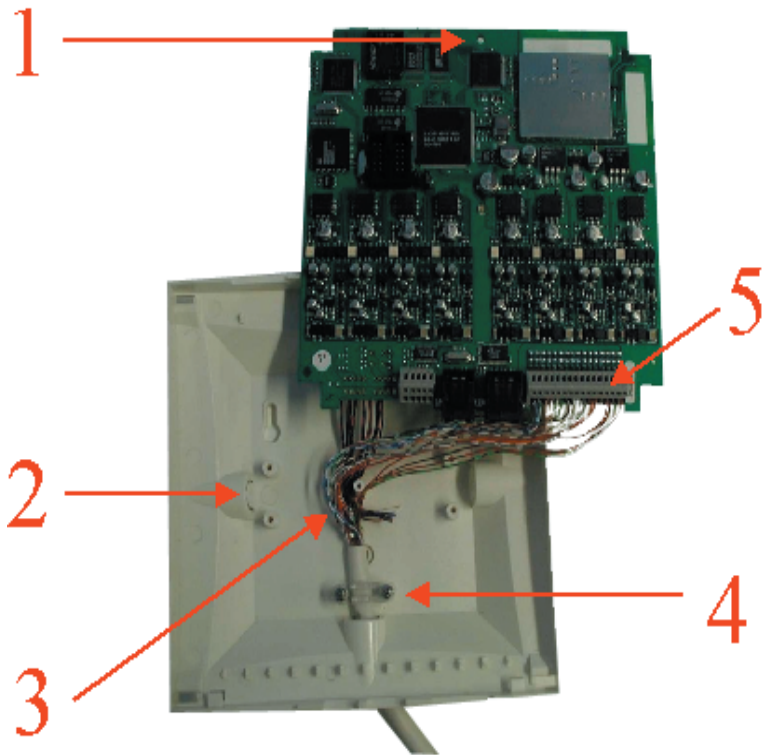

The connectors are laid out as follows:

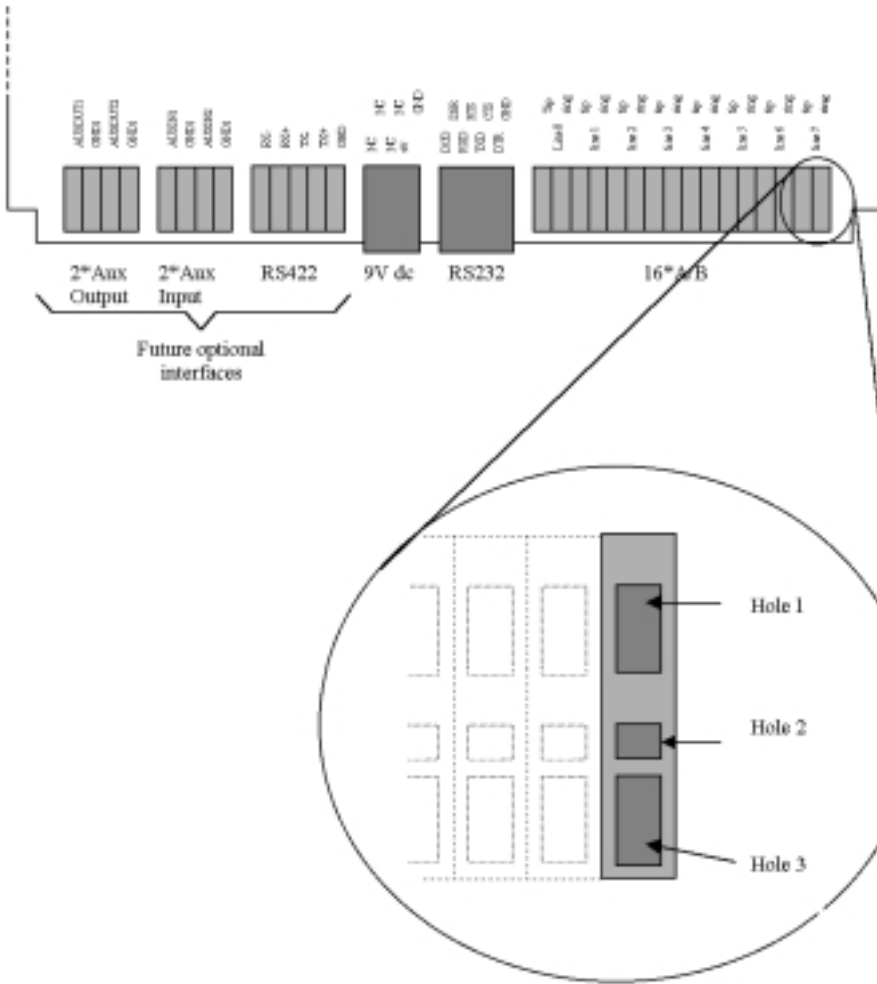

The connector for the 9V dc is a 6/6 modular plug, whilst the connector for the RS232 is an 8/8 modular plug. The other connectors are fast connectors. Release of the internal spring can be achieved by either pushing a 0,5 mm or similar small probe into hole 1 or 2 while pushing the stripped wire into hole 3. Check that the wire is secured by pulling the wire gently.

2.5 Powering Up and Testing

CS100 LED Display

When the CS100 Base Station is receiving a supply of power, the LED display will give you basic information as to its status.

| | |
|--------------|-------------------|
| Green | Normal operation |
| Red | Fault |
| Flashing red | Subscription mode |

Testing Base Station / Repeater Signal Coverage

The radio coverage provided by the CS100 Base Station can be tested by using one or more handsets which has been registered to the system (See section 3.1 – ‘Registering the Master Handset’).

When carrying out this test, the handset must be ‘Off Hook’ in field-test mode. To set the handset to this mode, press “*99981*” followed by **OK**.

The display will now change to show the following:

| | |
|-------|-------|
| RPN: | 00 02 |
| Q52: | 64 |
| RSSI: | 55 40 |



RPN – The first number is the Base Station / Repeater that the handset is in communication with. The second number is the current preferred choice Repeater for handover of a call if the user is moving. These numbers will change as you move around.

Q52 – This is the audio quality indicator. A number between 60 and 64 is acceptable, with 64 being the best. Anything below 60 and the audio quality may deteriorate. This should also be checked by setting up a voice connection to check the speech quality.

RSSI – This stands for Received Signal Strength Indicator, and is a measure of the received signal from the Base Station or Repeater. This is used to determine when to ‘Hand Over’ a call. These readings are relative to each handset, and so variations between handset readouts are normal.

This page has intentionally been left blank.

Master Handset

3. **Master Handset Configuration**
 - 3.1 Configuring the Master Handset
 - 3.2 Registering the Master Handset
 - 3.3 Allocating the Master Extension number
 - 3.4 Registering additional handsets via the Master Handset
 - 3.5 Deleting previously Registered Handsets

3.1 Master Handset Configuration

Note: Administrative tasks may also be carried out using the System Administration software on any PC or Laptop running Microsoft Windows 95, 98 and 2000. This is recommended.

Software can be downloaded from www.multitone.com



The Master Handset

When the CS100 system powers up, it will automatically go into registration mode for a period of 15 minutes. During this time, you can register your 'Master' handset, which will be used for the following administrative functions:

- ⊙ Allocating master extension number
- ⊙ Registering additional handsets via Master handset
- ⊙ Deleting previously registered handsets
- ⊙ Registering a Repeater
- ⊙ Establishing Repeater jumps (Repeaters in a chain)

3.2 Registering the Master Handset

Before you begin, make a note of the CS100 identification number, located on the back of the unit (ARI number). During the registration process, the 1st handset you turn on automatically becomes the Master handset, and is configured to channel 00.

Follow these steps to complete the registration process: Check the software version (PCS 4I, PCS 4K etc.) before you begin *99982* OK

1. Turn the handset **ON**.
2. Press the **Menu** key.
3. Press the **Left Arrow** key twice.
4. The menu will now display 'Login'. Press the **OK** key, and the display will change to 'Select Login' (Handsets up to PCS 4I). Handsets with PCS 4K or later go to step 5 subscription create.
5. Press the **Right Arrow** key once, followed by **OK** (For handsets not previously registered.) Subscription create.



6. The display should now read 'Subscription Search ID' and it will begin to search for the CS100 ID number. When the handset finds a system, the ID number will appear in the display. If the handset detects more than one system, a black triangle will appear at the bottom of the display. Highlight your serial number by using the **Left** and **Right Arrow** keys on the Master handset.

ENSURE THAT THE NUMBER YOU SELECT EXACTLY MATCHES THAT ON YOUR CS100 SYSTEM UNIT, INDICATED AS AN ARI NUMBER!



7. When the correct ID number is highlighted, press the **OK** key twice on the Master handset to complete the registration process.

3.3 Allocating the Master extension number

To allocate the Master handset with an extension number, follow these steps:

1. Press the **Menu** key on the Master handset.
2. Press the **Right Arrow** key – the display will read 'EXT. Service'.
3. Press the **OK** key – the display will read 'Clip Stack'.
4. Press the **Left Arrow** key twice – the display will read 'read/Write userdata'.
5. Press the **OK** key.
6. The Serial Number of the Master handset will appear in the display – press the **OK** key.
7. The handset will now ask for an extension number – simply enter the existing extension number for the extension connected to the first port of the CS100.
8. Press the **OK** key.



To complete this process, the Master handset will need to be turned off and then back on again. The display will show 'DECT-CH70'. This handset can now be used to perform all administrative tasks.

3.4 Registering additional handsets via Master handset

Once the Master handset is configured, it can be used to register additional handsets to the CS100 System unit. If you want to register an additional handset, the Master handset must “allow” you to do so.

Follow these steps to register additional handsets:

1. Press the **Menu** key on the Master handset.
2. Press the **Right Arrow** key.
3. The display will read ‘EXT. Service’. Press **OK**.
4. The display will read ‘Clip Stack’. Press the **Left Arrow** key twice so that ‘Read/Write userdata’ appears on the display.
5. Press **OK**, and the serial number of the Master will appear on the display.
6. Using the **Right Arrow** key, scroll through the list of available positions (channel 01 – 07). If a position is empty, the display will show “_____”.
7. Enter the **serial number** of the handset you wish to add. (The serial number may be found on a label inside the handset beneath the battery. It will begin “00077-xxxx”. When entered, press **OK**).
8. The handset will now ask for an extension number. Simply enter the desired number and press **OK** (the extension number should be the same as the PBX extension number for the port on the CS100 you have assigned the handset to).
9. Press the **Left Arrow** key to return to the registration menu, and repeat these steps to add more handsets.



The Master handset has now “allowed” the system to register the new handset.

The additional handset must be registered using the same process described in section 3.2

3.5 Deleting previously registered handsets

To delete a previously registered handset from the CS100 system, follow these steps:

1. Press the **Menu** key.
2. Press the **Right Arrow** key to select '*EXT. Service*' and press **OK**.
3. Press the **Left Arrow** key until '*Delete_user_info*' is highlighted and press **OK**.
4. Use the **Right Arrow** key to highlight the serial number of the handset you wish to delete, and then press **OK**.



The handset you selected via the serial number will no longer have access to the system, and will not be able to make or receive any calls.

PC Configuration

- 4. **PC Software Configuration**
 - 4.1 Installing the CCFP Administration Software
 - 4.2 Configuring the CCFP Software for the first time
 - ⊙ Phone Book
 - ⊙ Editing Phone Book
 - ⊙ Registration Screen
 - ⊙ CCFP Setup
 - ⊙ MSF
 - ⊙ MSF Status
 - ⊙ Status Message Level
 - ⊙ File Menu
 - ⊙ Options Menu
 - ⊙ Debug
 - ⊙ Impedance Setup

4. PC Configuration

The CS100 System CCFP Administration software is available to download from our website 'www.multitone.com'. This is a professional tool for programming the CS100 system for best performance. This software may be updated from time to time.

You can use the CCFP Software to input user information, and for configuring the CS100 to match the parameters of your connected PABX. It also contains diagnostic utilities to help with fault finding and troubleshooting.

The CCFP Software has an extremely useful help file that will explain in more detail some of the options outlined in this user guide.

4.1 Installing the CCFP Administration Software

The latest version of software is Revision 8.3 (Jan 2003)

After downloading the CCFP Administration software to a temp directory UnZip and follow the on screen installation instructions.

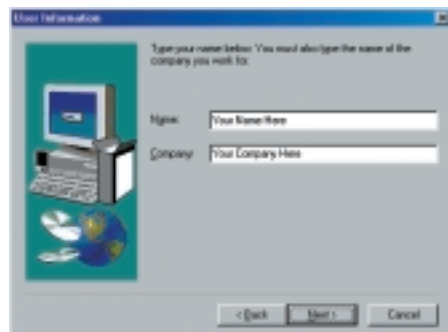
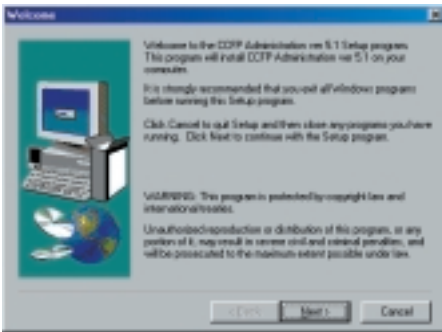

1. To begin the software installation process, click **Next**
2. Enter your name and company details, and click **Next**

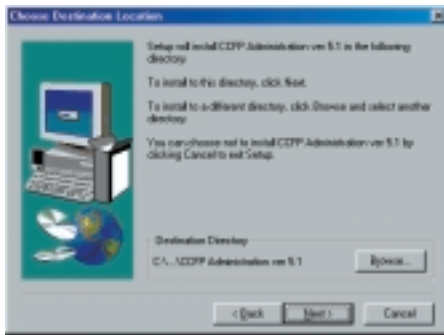

3. You can now specify in which directory to install the software. The default is c:\Program Files – to accept this, click **Next**

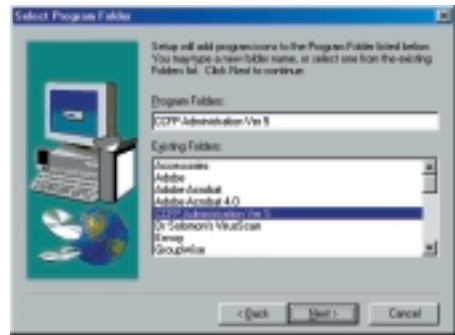

4. The installation will add shortcut icons to your start menu. This can be organised to suit your menu structure. Click **Next** to continue

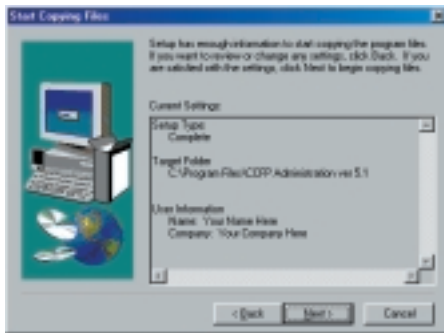

5. Before the files are copied to your computer, verify the details you have provided. If you are satisfied, click **Next**. Otherwise, use the **Back** button to make any changes

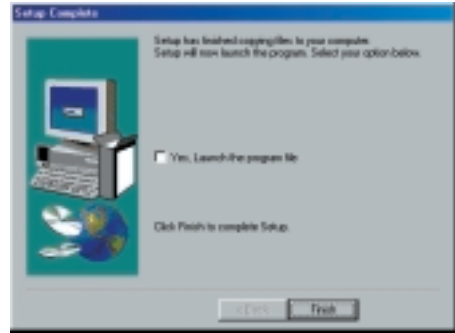

6. The installation is now complete, and the software has been copied to the directory you specified. Click **Finish** to return to your desktop

The software is now available from the Start menu at:

Start
Program
CCFP Administration Version X.X
CCFP Administration

Note:

The latest version of the software is available from the Multitone web site.

4.2 Configuring CCFP for the first time

When you first load the CCFP Administration software on your computer, it will automatically attempt to configure the connection settings to the CS100 Base station. The following screen will appear as this happens:



By default the program looks for a connection on COM1 via a Direct Connection. If these are not the correct settings, you can click on the **'Change Communications Configuration'** button.



Using this settings window, you can select between the available COM ports on your computer, and also between Direct Connection or Modem Connection.

Direct Connection: Connection directly from the CS100 System to the PC
Direct connection is limited to 3 Meters between the CCFP or 5 Meters using a modem driver.

Modem Connection: PC remotely accesses the CS100 System via the telephone system.

Phone Book

If you select **Modem Connection**, you have the option of setting up a Phone book. This is particularly useful if you administer several CS100 Base Stations.

The Phone Book will store the name and connection settings of each system you enter, allowing you to quickly select which system to enter via a drop-down menu.

The Phone Book also controls the dial-up connection to the CS100 Base Station. Once connected, the CCFP Administration Program will work the same as it would via a Direct Connection.

When you have entered the connection details, click **'Dial Number'**. When a connection is indicated in the 'Connection Status' box, click **'Proceed'**.



This will complete the connection and bring up the main CCFP administrator screen.

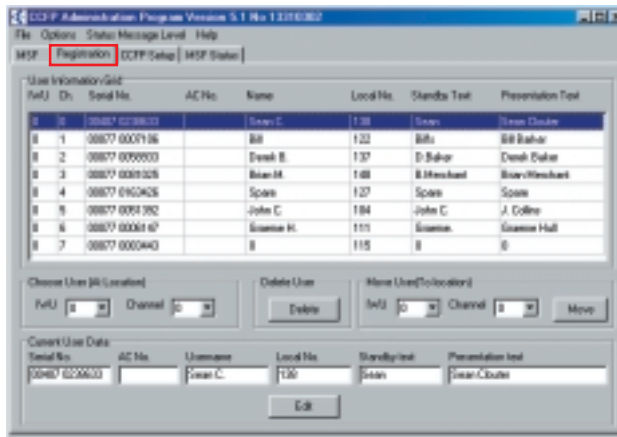

Editing the Phone Book

Within the CCFP administration program, there is an option under 'Options / Phone Book' for editing the Phonebook in the External Services in the handset.

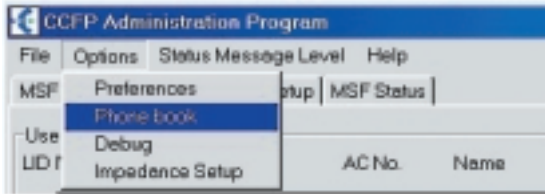

From the CCFP main screen select 'options' and 'phonebook'

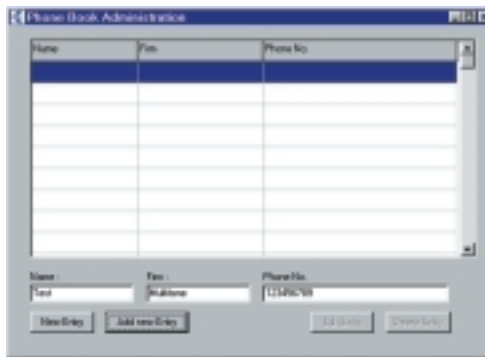

To add a new entry press the '**New Entry**' button, or choose the empty line at the bottom of the list. When all the information has been filled in press the '**Add Entry**' button.

To alter a existing entry chose the entry in the list, make the changes and press the '**Edit**' entry button, if the entry needs to be deleted press the '**System Overview**' button.

Data entry is limited as follows.

Name - 10 characters including spaces

Firm - 10 characters including spaces

Phone Number - 23 characters including spaces

When the CCFP administration program is closed.

MSF (Message Service Function)

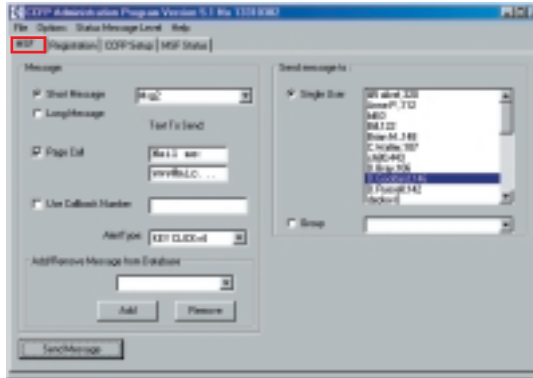

The Message Service Function (MSF) screen is used to send text messages from the PC to handsets. Messages can be sent to a single user, or in larger configurations to a group of users.

You can also set the MSF “Alert Type” to alter the way your phone will notify you of a call so that it is easily distinguishable from other calls.

MSF Screen.

Standard messages may be sent from a user create list by selecting the message and user/s.

Select “Send Message” to Transmit.

If the “Page Call” box is ticked and a local DECT extension number entered the message recipient can call back by going off hook. The number is dialed automatically.

Alert Type.

The Alert Type may be selected, this allows the receiver of a message to discriminate on urgency.

MSF Status

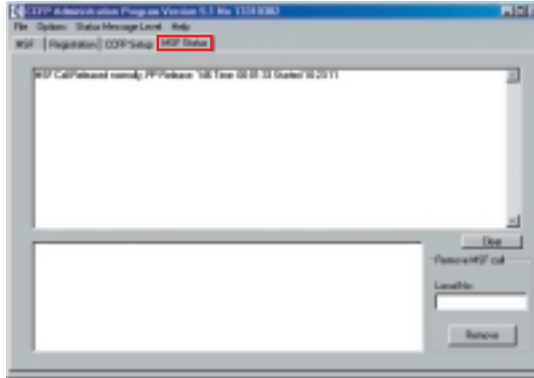

The MSF Status screen displays information on text messages that are in transit, and that have been received during the current session. The top half of the window lists messages that have been read by the user, whilst the bottom half displays messages pending.

Using this information, you can cancel any message that is yet to be read by a user.

Registration Screen

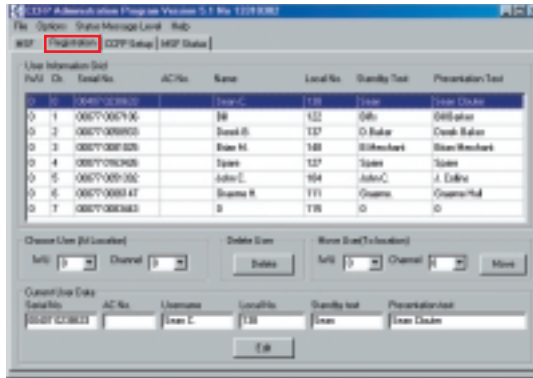

The Registration screen is used to input configuration details of the handset and the user. The first handset you register – even if it isn't channel 00 - will become the Master handset, giving it local administrative functionality.

As well as registering users and handsets, you can also move or delete users.

1. Enter user data in the bottom row of entry boxes.
 - Handset serial number must have a space between 00077-xxx
 - A/C number (none by default)
 - User name maximum of 10 characters
 - Local user number - maximum of 12 characters
 - Stand by text (Name, Extension, Job name) maximum 24 Characters
 - Presentation text.(this is information sent to another DECT handset when called (Name, Extension, Job name), maximum 32 characters - 3 lines of 12-12-10 characters no text wrap.)
2. Select 'Create' to load the Data.
3. To register handsets
 - Options
 - Preferences
 - Tick the box 'Allow Subscription'.
4. Register each handset.

Handset data may be edited by selecting the user and 'edit'.
Select 'edit' to confirm the changes made.

Handset Registration

To register the handsets on to the CS100 , registration must be 'allowed'.

1. Select options-preferences
 2. Select 'allow subscription' and 'ok' then 'close'
- Handsets may now be registered.

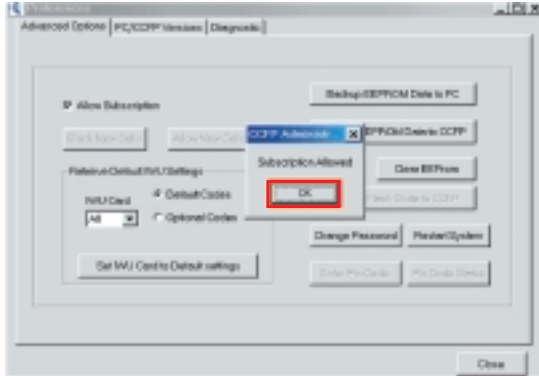

1. Menu.
2. Left arrow twice
3. Menu Login - OK
4. Menu Select Login - OK
5. Select Login System 1 - 4 on handset PIE up to 4!

If the 'Login' slot has been used the ARI number of the system will be displayed, you can check the s/w version by *99982* OK.
CH70 PIE 4K or Later. Go to step 7 if this is the first time the handset has been registered.
6. Select - OK. The Handset will beep.
7. Left arrow twice to 'subscription create' - OK
8. Select - OK. and 'Create system 1 - 4'. AC____ will be displayed, use arrow keys to select the same registration slot as the login. (Login 1 = System AC1).
9. Press - OK to register the handset after a short period of time the handset should beep once. If the handset beeps several times and the message "subscription failed" is displayed go back to the start of the handset registration and begin again.

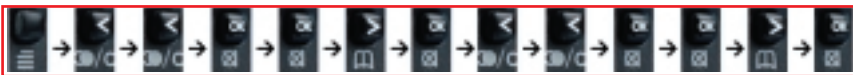

Registration failure checks:

- Registration Not enabled
- Wrong slot selected (AC1 = Login1)
- Handset ID incorrect or not entered into system.
- AC Number required.

CCFP Setup



The CCFP Setup screen is used for configuring IWU parameters to match the parameters of the connected PABX.

CCFP Setup should only be reconfigured by users who have attended a Multitone CS100 Administration training course. Please contact your distributor for details.

Menu: File

Open: A previously saved configuration can be restored onto the CS100 System

Save / Save As: Existing User and IWU configurations can be saved and backed up

Exit: Exits the program

Note: Opening a new file – even if it is the same file as is already loaded onto the system – will de-subscribe all handsets. This will also reconfigure a new Master handset.



Menu: Options

The Options Menu contains commands for viewing system information, backup/restore of CCFP data and commands for debug purposes.

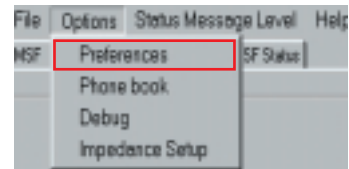

Preferences

The Preferences option contains advanced settings and configuration information.

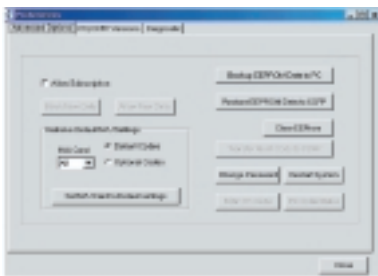

Advanced Options:

- ⊙ Allow Subscription
- ⊙ IWU Card settings
- ⊙ Clear / Restart the system
- ⊙ Enter or change password



PC/CCFP Versions:

- ⊙ ARI (Serial) Information
- ⊙ Flash Program part number
- ⊙ Flash Program edition

Technical Appendix

Impedance Setup

The line impedance to the PABX is adjusted using the Impedance Setup option.

The default line impedance settings is Complex (Low).

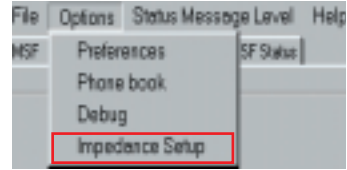

Click to view current status

Additional setting – Real (High 600ohm)

Each channel can be adjusted separately

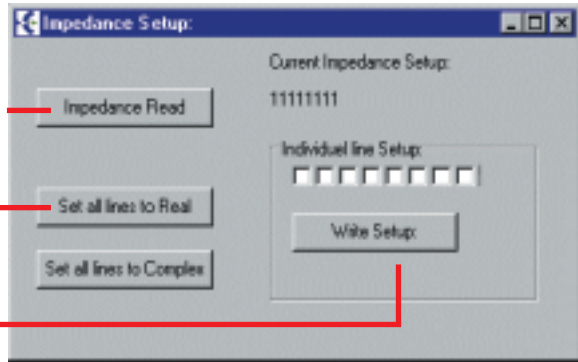

5. Repeater and Handset Programming

Software for programming repeaters and handsets can be downloaded from www.multitone.com . The following features can be programmed.

- 5.1 Startup text
- 5.2 Instructions for Installation and Configuration of a Repeater
- 5.3 Setting up Repeaters
- 5.4 Determining Where to Locate a Repeater
- 5.5 Registering a Repeater
- 5.6 Establishing Repeater Jumps

5.1

Start-up text

Programming the handset start up text requires the Kirktool software and a CH70-DS Docking station.

The Start-up text can be written in 3 lines of the display. As soon as the box 3040 PP is marked, the option of writing the text in 3 lines will appear.

The current version of software revision 4.6 has a number of features.

- Volume adjustment for PPI Handset - DO NOT USE.
- Start up text - used to enter start up text on CH70 Handsets.
- Repeater - used to program repeaters on CS600 and CS100.
- Communications - used to set the com port for programming.
- Download - used for loading alternative languages.
- Gain Control - used for setting handset volume.

5.2 Instructions for installation and configuration of a Multitone Repeater

Repeater Installation

The following tools and software are required for the programming of repeaters on the CS100

- ⊙ Drill, Drill Bits, Rawlplugs and Screws
- ⊙ Repeater Programming Kit - Part No. CS600 - PRG - Kit
 - ⊙ This includes a programming cable and special two way adaptor.
 - ⊙ Software must be downloaded from the Multitone web-site www.multitone.com

Mounting the repeater

- ⊙ Location

The repeater must be located within 3 metres of a 230 Volt Main socket. The socket should be marked "DO NOT TURN OFF"
- ⊙ Power

The repeater must be located away from any structure or object that could reduce or obstruct the radio transmissions. It is critical that the repeater is tested in its preferred location before final fixing takes place.

Final Fixing

1. Pull the wire from the power supply, through the wall holder and then mount the wall holder on the wall.
2. Connect the wire to the plug on the back of the WRFP and 'click' the WRFP onto the wall holder.

If you need to remove the repeater, please separate it from the wall holder with a gentle push of a screwdriver.

For further information and technical support please contact Multitone Electronics website www.multitone.com

Programming the CS100 Repeater

We recommend you use the following instructions for programming the repeater.

- ⦿ Identify the preferred location for the repeater by measuring the received signal strength walking away from the base station using the feature code*99981*. The display will show RPN:xx which is the base station,Q52:64 which is the radio data and RSSI:xx which is the signal strength.
- ⦿ We recommend that a call is set up between two DECT handsets and that one person walks away from the base station observing the display and continuing a conversation. Move to the location where the repeater is required checking that the Q52 reading remains at 64 and that the speech quality remains good. If at any time either of these factors change, you have reached the maximum recommended distance from the base station to where the repeater may be located.
- ⦿ Repeat this process for any additional repeaters, ensuring that the test handset is using the base station or the repeater for its communications. This is critical if repeaters are to be placed in a chain as the signal measurement and speech quality **MUST** be checked from the repeater. Section 5.3 provides detail instructions.
- ⦿ Handset feature codes
 - *99981* OK Signal strength
 - *99982* OK Software version
 - *99985* OK Battery status
 - *99989* OK 4 Channel coverage test

5.3 Setting up Repeaters

For the moment, it is recommended that you skip this section until the Master Handset has been registered. You can then use that handset to test the coverage and range of the CS100 Base Station, and use the results to determine where your Repeaters should be located.

If you have weak spots within your office or work place, you can set up a series of Repeaters to extend the coverage. It is important to place these Repeaters in their optimum position so that the coverage area is increased as much as possible.

For information on testing the coverage and signal strength, see section 5 'Powering up and Testing'. Once you have determined where your weak areas are, set up the Repeater and configure it using the instructions found in Chapter 5. Finally, test the area again and ensure coverage is now sufficient.

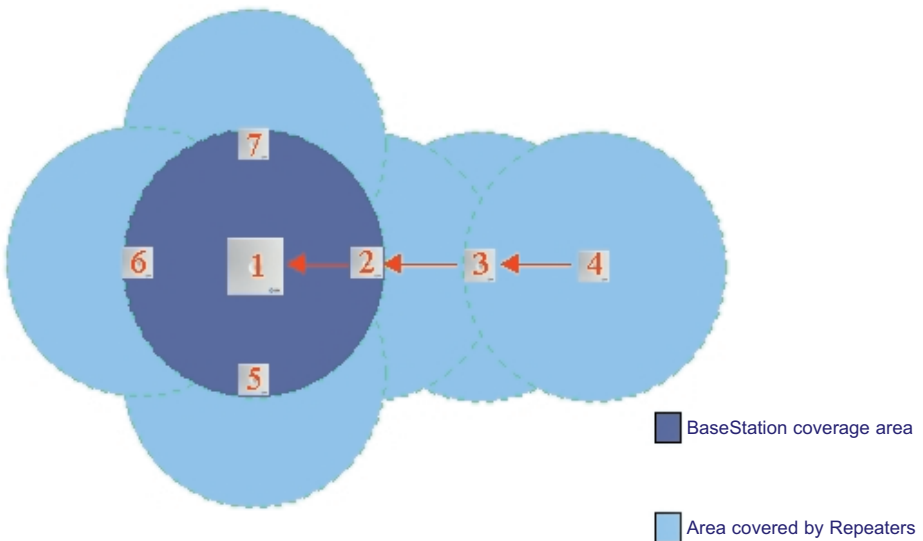

Repeaters can only be set up using a PC – NOT through the Master handset.

5.4 Determining where to locate a Repeater

Because of the unlimited variations in working environments, determining where to place a Repeater can never be exact. Signal strength depends on many outside influences, and so the best method of finding your ideal location for a Repeater is by using the signal coverage test.

Once the CS100 Base Station is operational, and the handsets have been registered, use the signal coverage test to find where your weak areas are. Set up a handset in Field Test mode (*99981* and then enter) and slowly walk away from the Base Station, keeping an eye on the Q52 readout. As you get further away from the Base Station, this number will decrease in value. When the Q52 readout falls below 60, mark the area as a weak spot. Once you have marked out all the potential weak spots within the area you need to cover, you can then decide the best location of a Repeater to gain maximum range.

A voice call between two handsets is strongly recommended to ensure that the call quality is constant. In some environments it is possible for the Q52=64 but for speech quality to be poor.

5.5 Kirktool Software Installation

If you have added any repeaters to your configuration to extend the area of coverage, you will need to register these using a PC before they can handle call coverage. The software is supplied when you purchase an additional Repeater, and is called Kirktool.

This can be downloaded from the Multitone website. This software is frequently updated and may not be the same as shown in this guide.

The latest Version of this software is rev4.5

To install Kirktool, follow these steps, insert the Disk and double click the icon labelled 'setup.exe'. Then follow these steps:

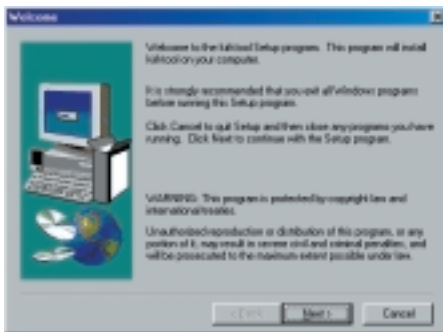

1. Click **Next** to begin the installation

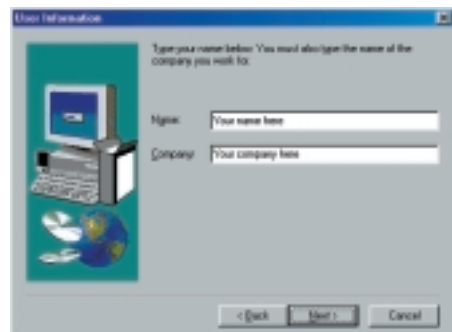

2. Enter your name and company details, and click **Next**

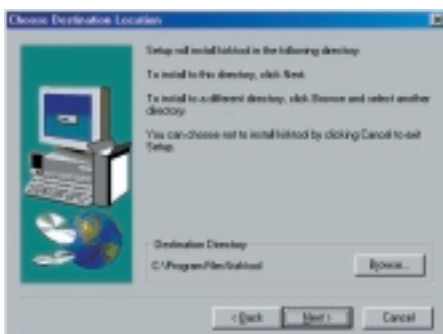

3. Enter the path for the installation files to be installed to, and then click **Next**

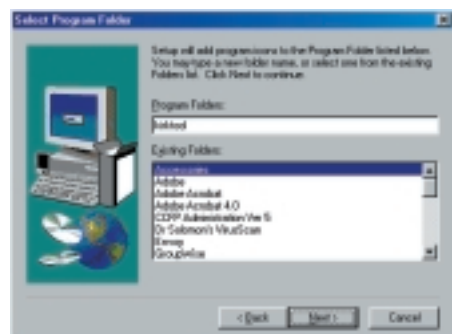

4. Click **Next** to create a new shortcut in your Start menu

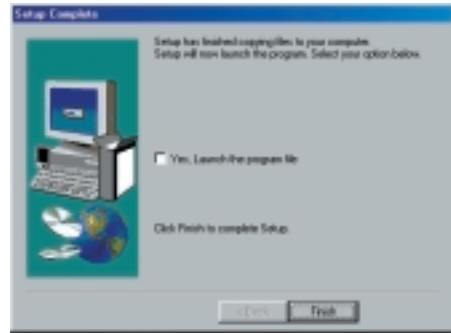
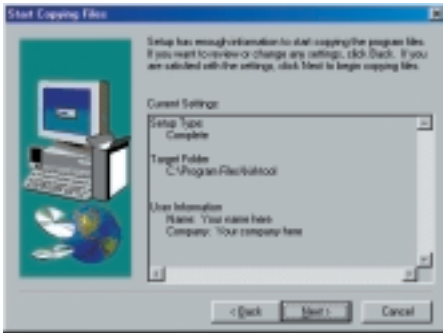

5. Verify your installation settings, and click **Next** to begin copying files

6. Installation is now complete – click **Finish**

Communicating with the Kirktool Software

Before you begin, ensure the Repeater is connected to the computer, and that the power is connected.

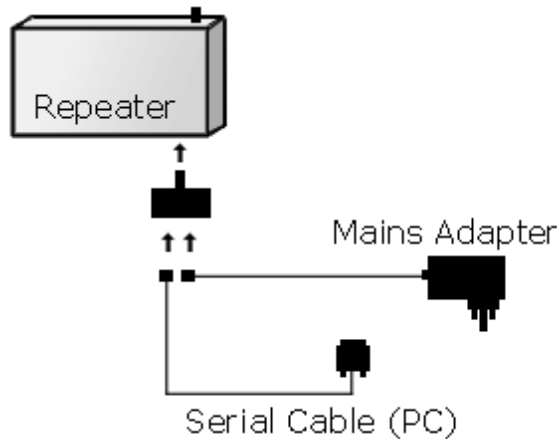

When the Kirktool software has been installed to the computer, you can load it from your Start menu by clicking:

Start
Programs
Kirktool
Kirktool

Repeaters

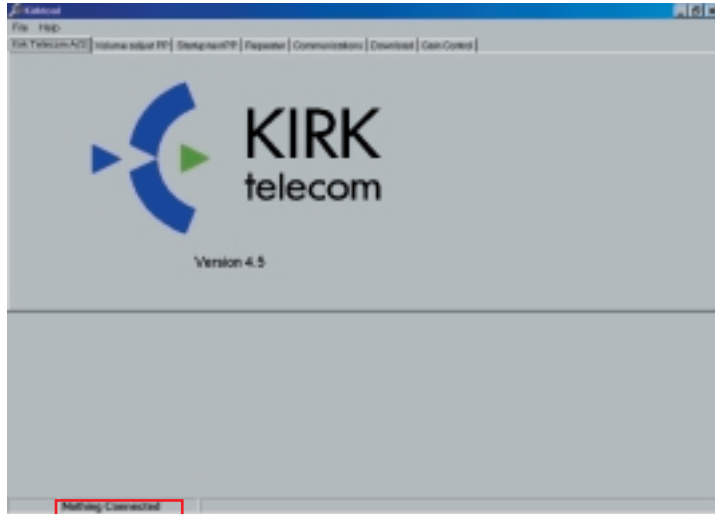

By default, the Repeater will not be detected by the Kirktool software, indicated by 'Nothing Connected' in the Status Message box. To allow the software to detect the Repeater, you need to set the communication method in the '**Communication**' tab at the top.

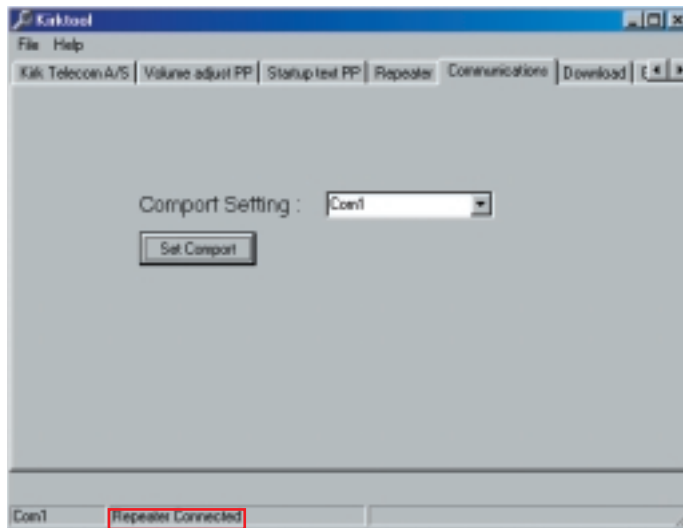

Select the COM port you have attached the Repeater to (Usually COM1 or COM2) and then click '**Set Comport**'. The Status Box should now indicate that the Repeater is connected, and you are ready to configure the Repeater.

5.6 Registering a Repeater

Select the **Repeater** tab to the left of Communications, and click the '**Residential Base**' button to switch to CS100 mode. The following screen will be displayed:

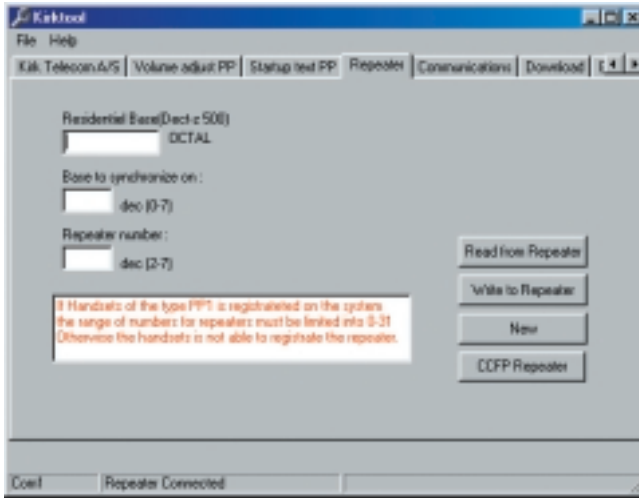

- Read from Repeater** Reads the current configuration settings directly from the Repeater

- Write to Repeater** Writes the configuration settings you have entered to the repeater. Your settings will automatically be checked to make sure they are valid

- New** Clears all configuration settings in the software

- CCFP repeater base** Switches mode between Residential and CCFP Repeater mode - Select Residential (CS100)

- Residential base (DECT-z 500) (CS100)** The residential base number (from the label on the rear side of the Base, for example 000046400266). The initial 4 zero's are not required in the number, so you can simply enter 46400266

- Base to synchronise on** The number of the residential base, which the repeater must synchronise on. The number must be between 01 and 07

Repeaters

Repeater number

This is the number to assign to the repeater. The assigned number of the repeater must be between 02 and 07

Example:

| | |
|------------------------|----------------|
| CS100 Base Station | 0000(46423641) |
| Base to synchronise on | 01 |
| Repeater Number | 02 |

- ⊙ When the Base station number, Synchronisation numbers and Repeater number are entered "Write to repeater".
 - ⊙ The entry box background will change from yellow to white
 - ⊙ To check the data has been written to the repeater.
 - ⊙ Select "New" to clear data
 - ⊙ Select "Read from Repeater" to check that it has been written correctly
 - ⊙ Disconnect the programming cable from the repeater and wait at least 20 seconds before plugging in the power lead.
 - ⊙ Check the repeater is on line
 - ⊙ Red LED is flashing.
 - ⊙ *99981* OK - Base Stations are shown - RPN - 01, 02
- Press and hold < to clear the screen.

5.7 Establishing Repeater jumps

If you have a particularly large area you need to cover that extends beyond the range of the CS100 System AND 1 Repeater, you can create a signal 'Chain' by adding an extra repeater. For example:

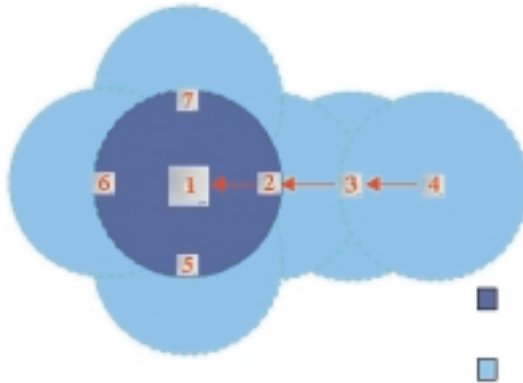

An extended 'Repeater Chain' allows for coverage far beyond the range of a single CS100 System, ensuring whatever the layout of your facilities space, the CS100 System can adapt to suit your needs.

To configure a Repeater Chain, use the Kirktool software to synchronise the repeater to an existing Repeater base number.

| CS100 | Repeater 1 | Repeater 2 (Extended) |
|---|---|---|
|  |  |  |
| S/N 000046423641 Base number 1 | Residential Base = 46423641 Base to synchronise on = 1 Repeater Number = 2 | Residential Base = 46423641 Base to synchronise on = 2 Repeater Number = 3 |

6.0 Frequently Asked Questions

What is DECT?

DECT is the acronym used for Digitally Enhanced Cordless Telephony or Telecommunications a global open specification offering speech quality equal to that found on a fixed line. Conversations are fully secure thanks to the speech channel encryption.

During the registration process, why does the Master handset detect more than one ID number?

This will happen when the handset detects another DECT system within its transmission range which is in subscription mode. Subscription will only be allowed to the CS100 system whose ID number is on the base of the unit. This does not breach any safety or security issues.

If I have added Repeaters to my configuration, can I also add more handsets?

The function of a Repeater is to extend the area of coverage for your existing handsets. It does not add to the capacity of the existing configuration (i.e. more channels).

I have recently installed a Repeater in my facility, but I cannot register it with the CS100 System.

When you register a Repeater to the system, it must be situated within the coverage area of the CS100 Base Station.

Why can fewer people make or receive calls in the coverage area of a Repeater or Repeater Chain than within the coverage area of the CS100 Base Station?

A Repeater is not designed to increase the **capacity** of the coverage area, meaning that the CS100 System including Repeaters still has a maximum of 6 simultaneous traffic channels. However, only the CS100 Base Station itself can provide service to all these channels within its range. A Repeater 'borrows' 2 channels for its extended coverage area, meaning that if you are only within range of the Repeater and not the CS100 Base Station, you will only have access to the 2 traffic channels as illustrated below:

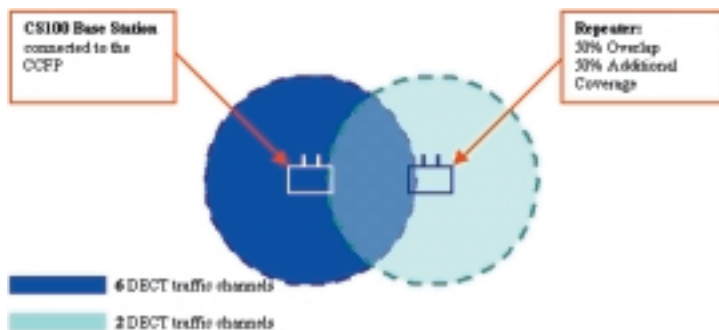

Can the CS100 system be connected to a public or private network?

This equipment is NOT intended to connect to a public or private network. It is only intended for closed connection to TNV2 circuits. This is a line supplied by a PBX and not exposed to over voltage such as may be induced on a PSTN line.

What happens when all 6 speech channels are in use?

Each handset uses 1 channel when making a call – either internally or externally. When 6 handsets are engaged in a call, the system sends out a busy signal. On the Multitone CH70 handset this is indicated by a flashing antenna icon, displayed in the bottom left of the screen.

Will my call get dropped if I walk to an area that is covered by a Repeater that is already in full use?

No. If during a telephone conversation you move to an area where coverage is not attainable, either because the system is full (all the lines are in use) or because you are simply coming to the end of the broadcast range, you will hear a Signal Warning beep. This ensures that you do not lose a call whilst on the move.

Why do Multitone not support the use of 3rd party handsets?

Multitone is continually striving to give our customers cordless systems that are both reliable and cost effective. We are constantly evaluating new DECT handsets as they come on the market as we are conscious that there are a lot of low cost 'Home base' products available which have a lower price than system handsets.

These handsets are designed for use with a single home base station with no requirement for handover, in some handsets the handover functionality in the embedded software has not been written, as it is not required. These units are produced in volume where the overriding factor in the design and build process is cost. In their own environment, 'the home' or small office, they work exceedingly well and are extremely good value for money.

However when used on a multi-cell system such as would be installed on a larger site requiring a number of base stations this lack of 'handover' functionality causes problems not only with the handset concerned but also with the system itself. After exhaustive tests at some of our sites using these low cost handsets it was discovered that these handsets generate a high overhead of radio traffic because of the number of additional radio cells that they can see in the Over Air Interface (OAI). This causes an inefficient use of the OAI and causes lost or dropped calls resulting in a poor system performance.

Multitone do not recommend nor support these low cost handsets and will therefore charge a supplement on existing contracts or callouts on sites which are found to be using these 'Home' products.

7.0 CS100 Messaging - P318 & Access Integrator-K

It is possible to increase even further the usefulness of a cordless environment by integrating fire alarms, burglar alarms, nurse call systems, messaging software, paging systems and simple switches (such as pressure pads, door bells etc.) with the CS100.

This can be achieved with the addition of Multitone Electronics' P318 or Access Integrator-K messaging interface.

The P318 has serial ports that can be configured to take direct data from TAP, ESPA and a range of other protocols. It also has 32 Voltage free contacts which can be configured as normally open or closed. The P318 will also allow the CH70 handset to activate these switches remotely by entering a code.

Activation of contacts can be programmed to send a message to a handset or team of handsets.

Examples of uses for Voltage free contacts:

- ⊙ Notify users of door bell push
- ⊙ Alert users to the customer presence via a pressure pad.
- ⊙ Pump or refrigeration alarms
- ⊙ Switch lights on or off via the handset
- ⊙ Panic buttons.

Access Integrator provides 16 Voltage free contacts connected to a LAN and has an Internet browser interface for easy to use system administration. Any PC with user rights can send messages to a single DECT handset or team of users, Access Integrator-K has two serial ports, one for connection to a Multitone CS100 or CS600 (Kirk system 1500 or 500) and a second serial port for TAP, MEP or ESPA input.

For further information visit the multitone web site www.multitone.com or contact your account manager.

This Page is intentionally blank

8.0 Technical Specifications

8.1 CS100 System features for all 8 DECT lines

| | |
|--------------------------|---|
| DTMF transmit: | All 16 (0-9, A, B, C, D, *, #) Duration 80, 90, 100 ms |
| DTMF receive: | All 16 (0-9, A, B, C, D, *, #) 1.5% + 5Hz Dynamic -4 - -28dB Tone duration > 50ms (option) Pause duration > 40ms Twist < 6dB Single tone receive: 300 – 2000 Hz |
| Single tone send: | Pulse send: 300 – 4000 Hz (option) Frequency (10 Hz) make/break:40ms/60ms or 34ms/66ms |
| Ringing receiver: | Duration > 200ms 20 – 120V 13Hz – 60Hz |
| Echo cancelling: | Overall echo reduction – 34dB |
| Canceller: | > 24 dB |
| Suppresser: | 12 dB |
| Loop break: | 100ms / 290ms / 630ms |

8.2 IWU Setup for CCFP Administration Program

Recall mode

Loop Break

Dial mode

DTMF

Pulse

Recall timing

Loop Break: 70ms
100ms
290ms
630ms

DTMF timing active = pause

70ms 150ms
80ms 200ms
90ms 250ms
100ms 2500ms

Pulse timing 10Hz

Make / break: 40ms / 60ms
34ms / 66ms

Dial tone detect pause

1 sec 4 sec
2 sec 6 sec
3 sec 8 sec

Ring freq.

13 – 60Hz
20 – 60Hz
20 – 30Hz

Dial tone filter

315 – 545Hz
385 – 465Hz
345 – 505Hz
265 – 600Hz

Suppresser

Office
Light noise
Heavy noise
Extreme noise
OFF

All have the option of either 9 or 12dB

